

Parts Guide

For Water-Filled Products

Sentry Water-Cable Barrier

SLED

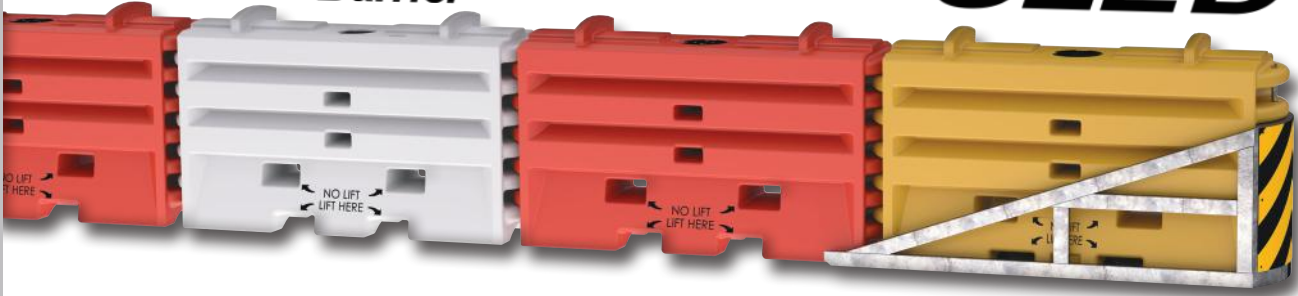

SLED mini

TraFFix WATER-CABLE Barrier



TraFFix Water-Wall



**TraFFix
Devices Inc.** 
Engineered Products for Safer Highways
160 Avenida La Pata
San Clemente, CA 92673

This page intentionally left blank.

Table of Contents

Section 1: Traffix Water-Wall & Water-Cable Barrier

Traffix Water-Wall Module	05
Traffix Water-Wall Specifications	06
Traffix Water-Cable Barrier Module.....	07
Traffix Water-Cable Barrier Specifications.....	08
90 Deg Corner Pin	09
Sled Mini End Treatment	10
Hardware.....	11

Section 2: Fencing For Traffix Water-Wall & Water-Cable Barrier

Configurations.....	13
T-Pin and 90 Deg Rotation.....	14
Accessories & Dimensions	15
Hardware.....	16

Section 3: Sentry Water-Cable Barrier

Module	19
Specifications	20
End Treatment.....	21
Hardware.....	22

**Section 1:
TraFFix Water-Wall
&
TraFFix Water-Cable Barrier**

TraFFix Water-Wall Module

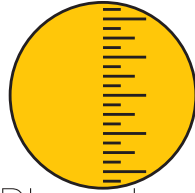

Dimensions

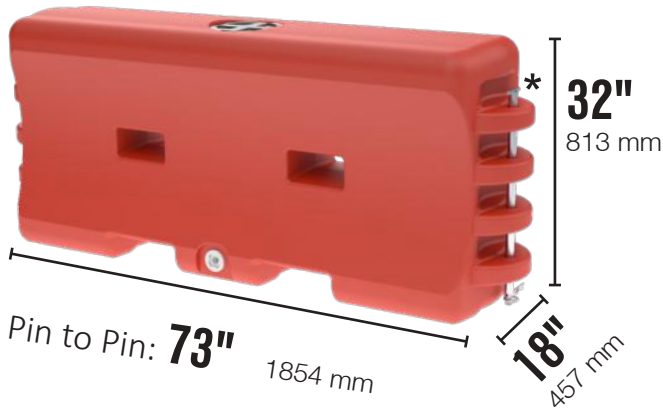

Red/Orange Module:
45032-O

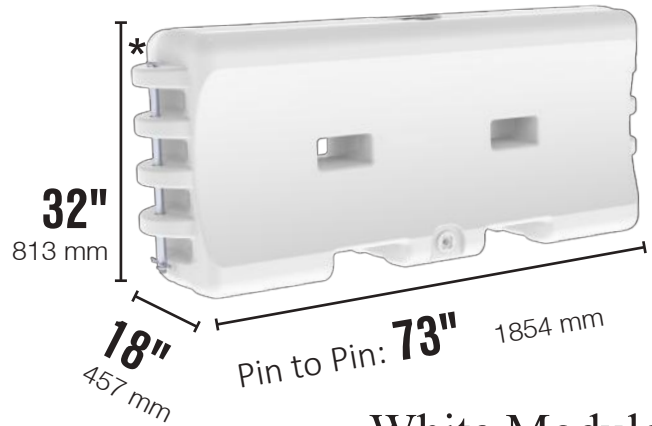

White Module:
45032-W

**Includes One T-Pin and Keeper Pin*

Water Wall Module



Empty Weight:
75 lbs (34 kg)



Material:
Polyethylene

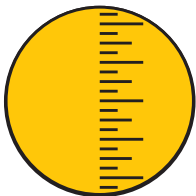

Dimensions:
Length: **73" (1854 mm)**
Width: **18" (457 mm)**
Height: **32" (813 mm)**

Filled Water Wall Module



Filled Weight:
1000 lbs (454 kg)

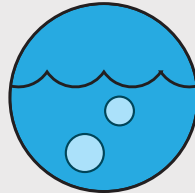

Water Volume:
111 Gal (420 L)



Fill Cap
Black Fill Cap

TraFFix Water-Wall Specifications

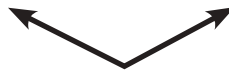

Forklift/Pallet Jack Slots,
For Easy Movement and Transport

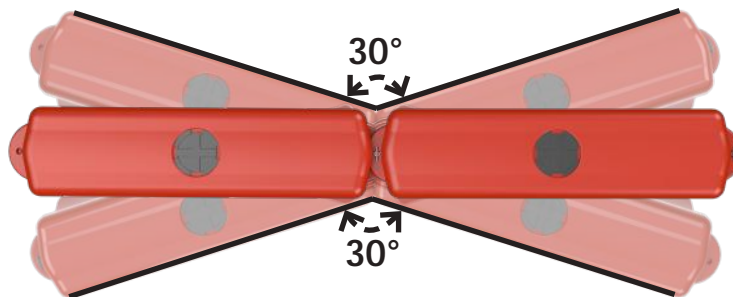

30°
Maximum Rotation

TrafFix Water-Cable Barrier Module

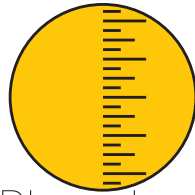

Dimensions

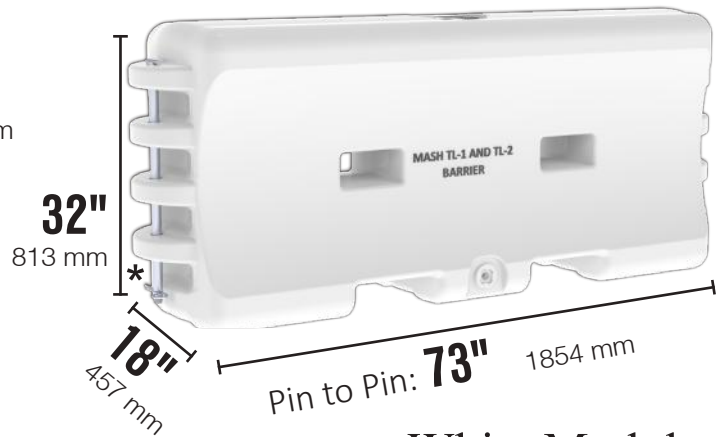

Red/Orange Module:
45332-MO

**Includes One T-Pin and
Keeper Pin*

White Module:
45332-MW

Water-Cable Module



Empty Weight:
110 lbs (50 kg)



Material:
Polyethylene

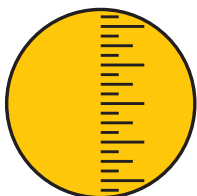

Dimensions:
Length: **73" (1854 mm)**
Width: **18" (457 mm)**
Height: **32" (813 mm)**

Filled Water-Cable Module



Filled Weight:
1100 lbs (500 kg)

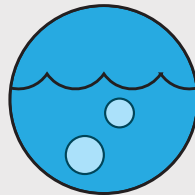

Water Volume:
111 Gal (420 L)



Fill Cap
Black Fill Cap

TrafFix Water-Cable Barrier Specifications

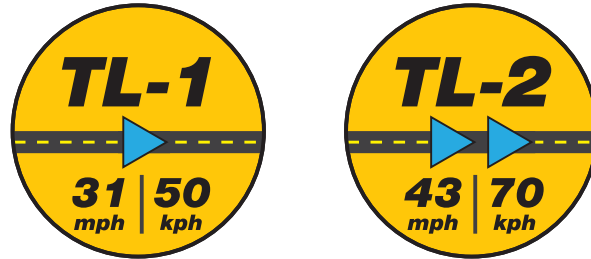

Three Internally Molded-In Steel Cables

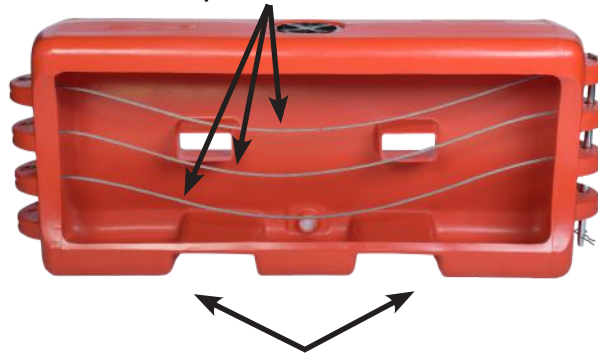

Forklift/Pallet Jack Slots,
For Easy Movement and Transport

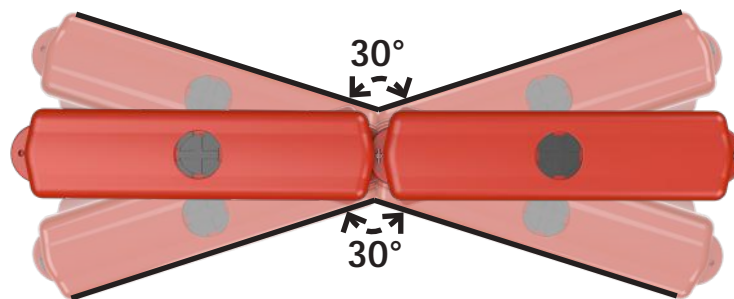

30°
Maximum Rotation

90° Corner Pin Rotation



**Corner Pin Sold Separately*
See page 11

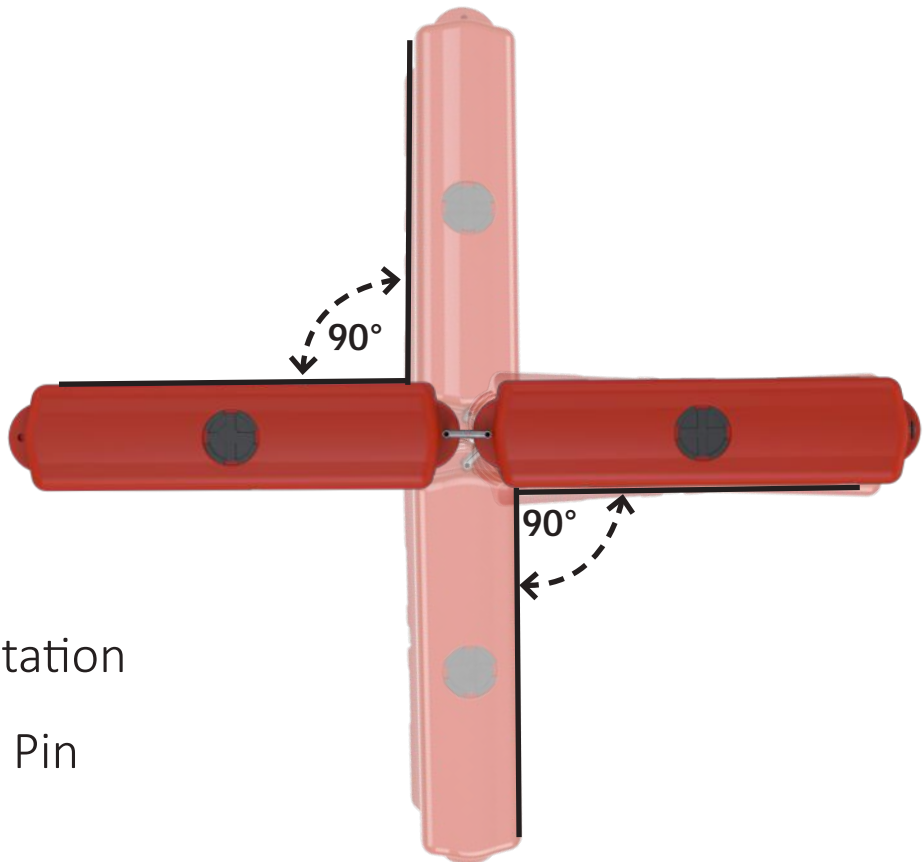

90°
Maximum Rotation
With
90° Corner Pin

SLED mini End Treatment



45032-Y-CIS



45032-S



45332-MY

Hardware



45032-CPGAL
T-Pin

45032-CP
T-Pin with Keeper Pin



45032-PN
Keeper Pin (R-Clip)



45033-RC-B
Plastic Drain Plug



45032-DPT
Drain Plug Socket Tool



45032-WW90
90° Corner Pin



45032-PDW
Plastic Drain Plug Wrench



18009-BLK
No Fill Cap



18009-B-I
Drive By Float
Lid*Optional



45032-DW
Steel Drain Plug Wrench

**Section 2:
Fencing For
TraFFix Water-Wall
&
TraFFix Water-Cable Barrier**

Fence Configurations

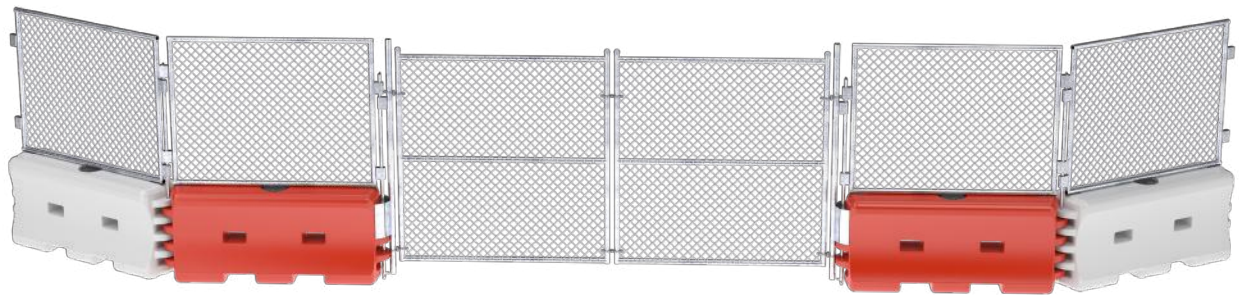
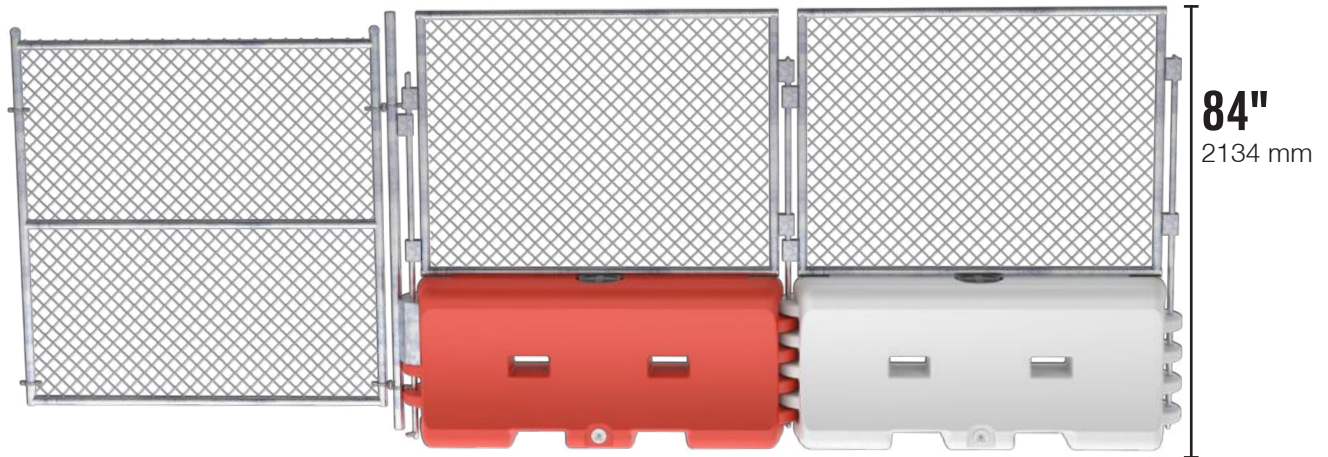

Two 6' Gates Can Be Combined
Making a 12' Gate



Maximum Rotation With
90° Corner Pin

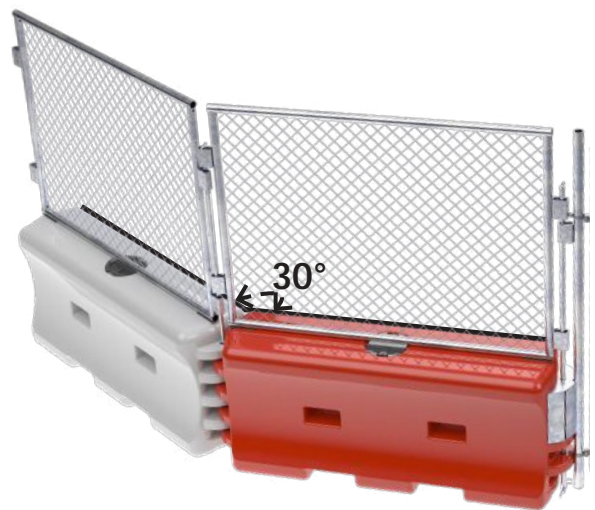

Maximum Rotation With
6ft T-Pin

T-Pin & 90° Deg Rotation

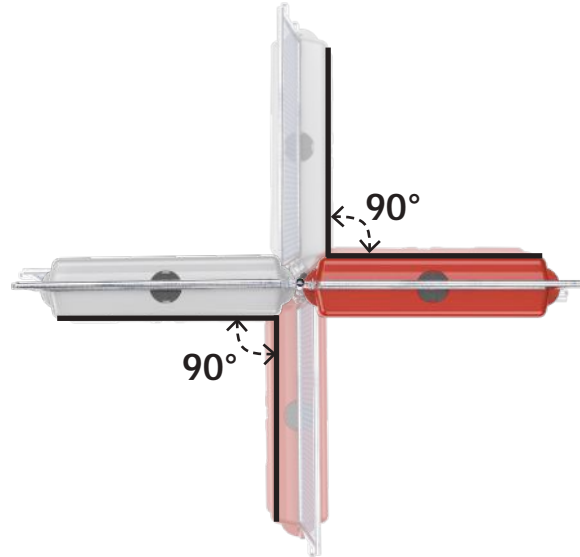

**Fence Corner Pin Sold Separately See page 16*

90°
Maximum Rotation With
90° Fence Corner Pin

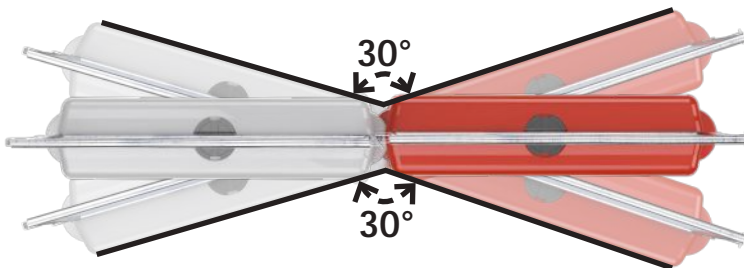

**One 6ft T-Pin and Keeper Pin Included With
Water Wall Fence Panel*

30°
Maximum Rotation
With 6ft T-Pin

Fence Accessories & Dimensions

45032-WWFG-C
Water-Wall Gate

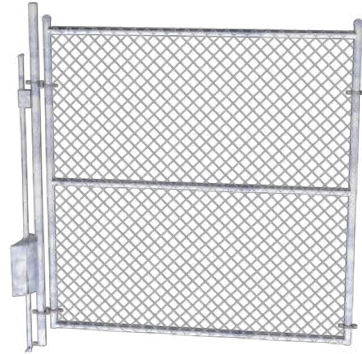

45032-WWFG-C3
Water-Wall Personnel Gate



6' 1829 mm
T-Pin with Keeper Pin:
45032-WWF-CP

3' 1000 mm



6' 1880 mm

3' Single Gate:
45032-WWF-G3

6' 1829 mm

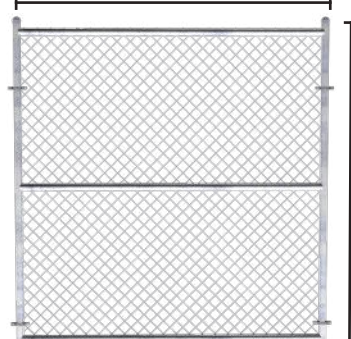

6' 1880 mm

6' Single Gate:
45032-WWF-G6

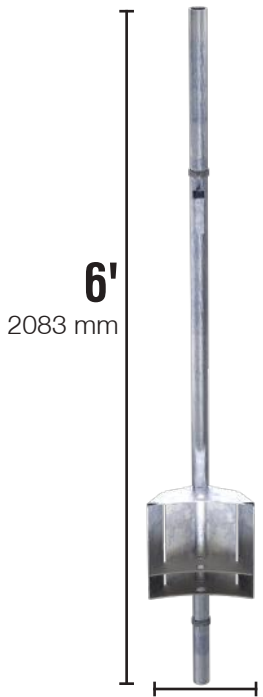

6' 2083 mm

Gate Attachment
Frame:
45032-WW-GA

12' 10973 mm

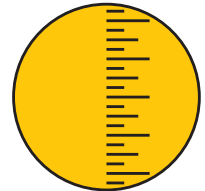

Dimensions

6' 1753 mm

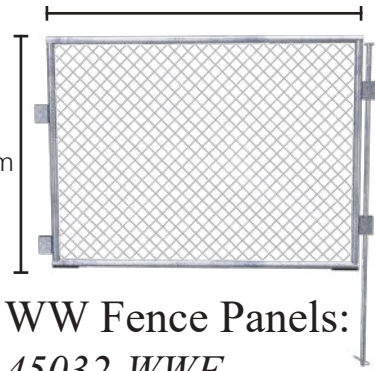

4' 1321 mm

WW Fence Panels:
45032-WWF

Fence Hardware

45032-WWF-CP

T-Pin with Keeper Pin



45032-WWF-CPGAL

T-Pin

45032-PN

Keeper Pin (R-Clip)



45033-RC-B

Plastic Drain Plug



45032-DPT

Drain Plug Socket Tool



45032-WWF90

90° Water-Wall Fence
Corner Pin



45032-WWF-GHF

Gate Hinge Female



45032-WWF-GHM

Gate Hinge Male



45032-WWF-GF

Gate Fork



45032-PDW

Plastic Drain Plug Wrench



18009-BLK

No Fill Cap



18009-B-I

Drive By Float

Lid*Optional

45032-DW

Steel Drain Plug Wrench



This page intentionally left blank.

Section 3: Sentry Water-Cable Barrier

Sentry Water-Cable Barrier Module

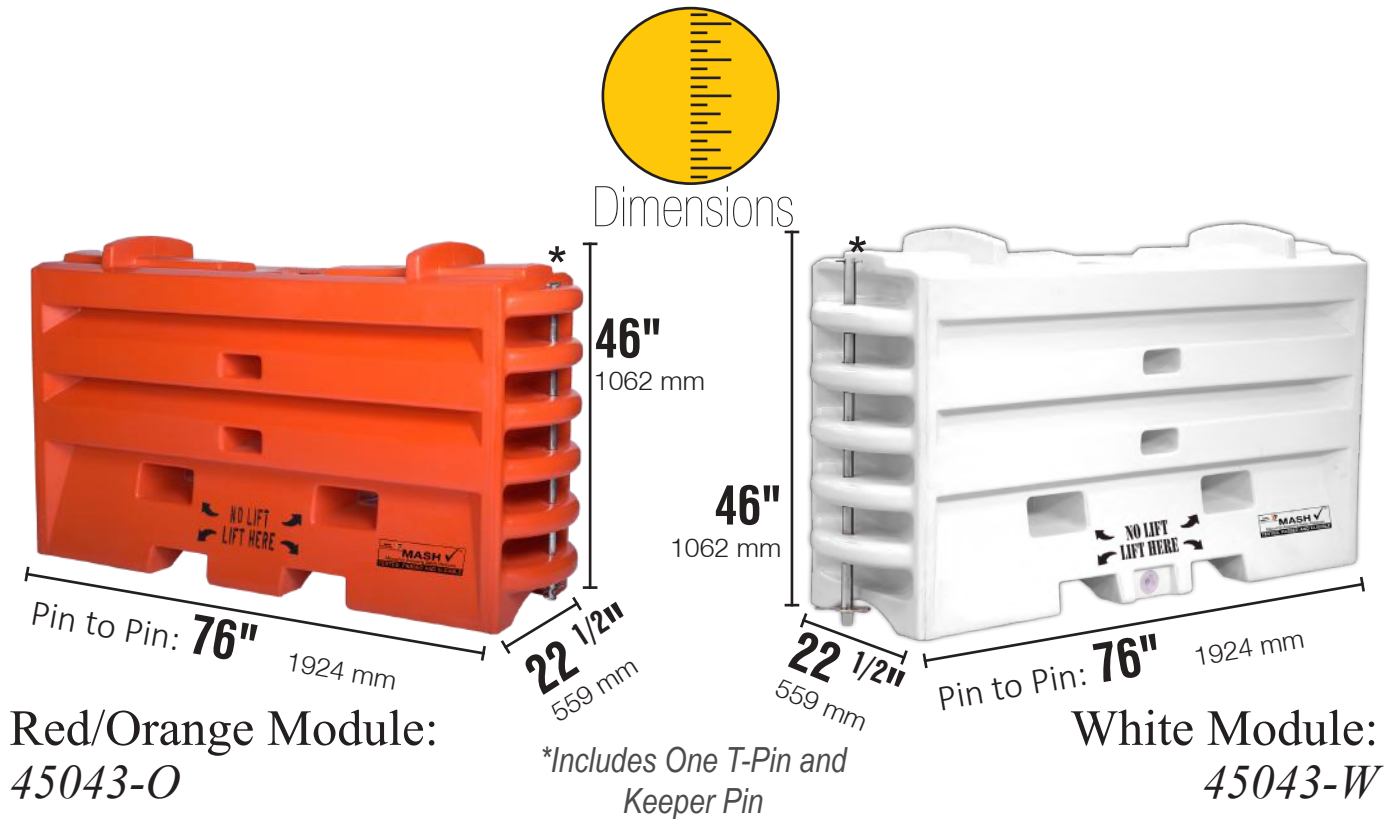

Sentry Water-Cable Barrier Module



Empty Weight:
160 lbs (73 kg)



Material:
Polyethylene

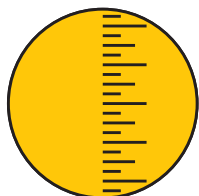

Dimensions:
Length: 76" (1924 mm)
Width: 22 1/2" (559 mm)
Height: 46" (1062 mm)

Filled Sentry Water-Cable Barrier Module



Filled Weight:
2000 lbs (907 kg)

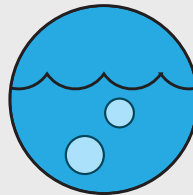

Water Volume:
220 Gal (832 L)



Fill Cap
Black Fill Cap

Sentry Water-Cable Barrier Specifications



Four Internally Molded-In Steel Cables

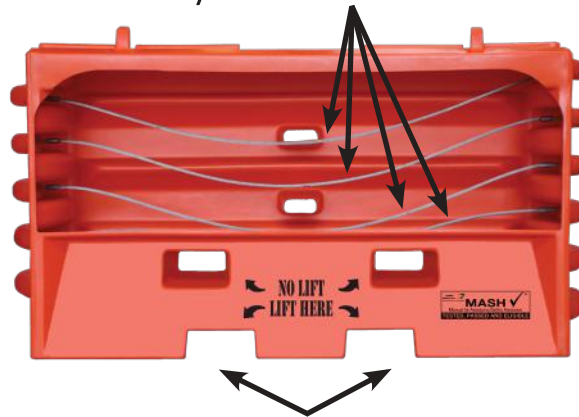

Forklift/Pallet Jack Slots,
For Easy Movement and Transport

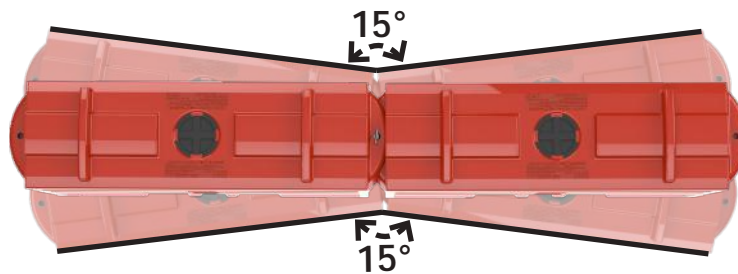

15°
Maximum Rotation

End Treatment For Sentry Water-Cable Barrier



45044-Y-CIS



45044-S



45044-YH

Sentry Water-Cable Barrier Hardware



45043-CPGAL
T-Pin

45043-CP
T-Pin with Keeper Pin

45032-PN
Keeper Pin (R-Clip)



45033-RC-B
Plastic Drain Plug



45032-DPT
Drain Plug Socket Tool



45032-PDW
Plastic Drain Plug Wrench



18009-B-I
Drive By Float
Lid *Optional

45032-DW
Steel Drain Plug Wrench



18009-BLK
No Fill Cap

This page intentionally left blank.

**TrafFix
Devices Inc.**



Engineered Products for Safer Highways

(949) 361-5663

© 2024 TrafFix Devices